

RM-1401

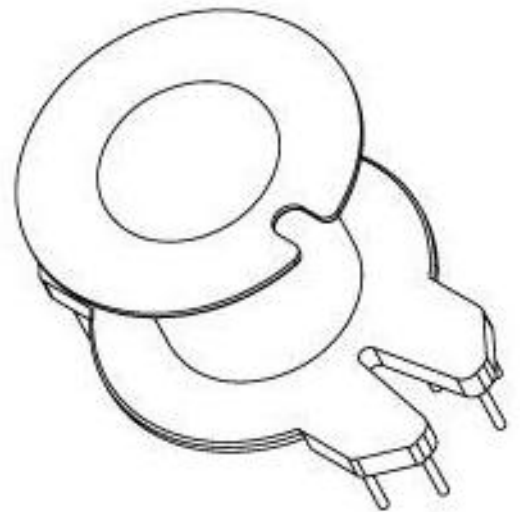
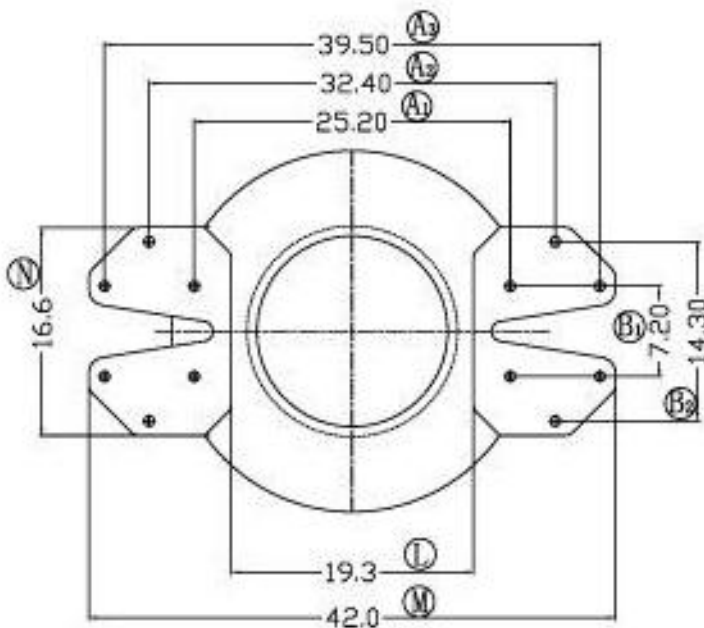
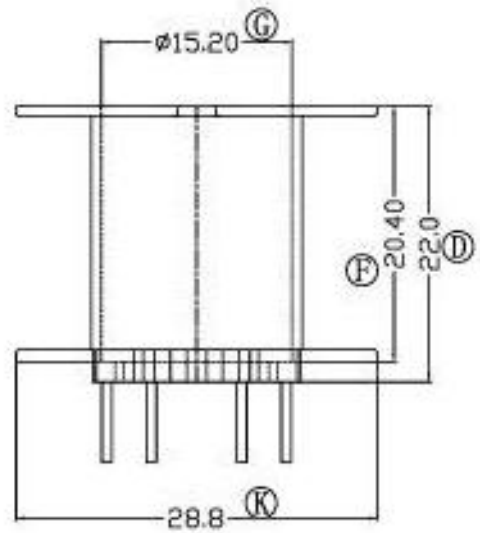
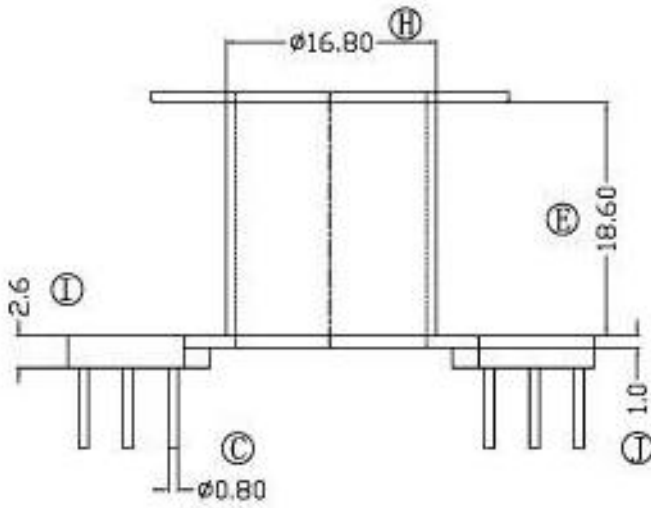

TOLERANCE		MODEL NAME: RM14-12P-1S	
X. X	± 0.3	BOBBIN MATERIAL: PHENOLIC	
X. XX	± 0.2	SCALE: 2:1	SCALE: UL 94V-0
壁厚:	± 0.15		SCALE: M/M
PINPITCH	± 0.2		